

Frigerio

DAO SOFT SOFA

Design Gordon Guillaumier

Un divano modulare che permette estrema libertà compositiva in un'armonia geometrica di morbidi volumi che, nella loro semplicità visiva, invitano con immediatezza a sperimentare calma e relax, sintonizzandosi con il ritmo del proprio respiro. Dao Soft, la nuova proposta di arredo firmata da Gordon Guillaumier, si caratterizza da alti schienali ed elementi di seduta imbottiti con diverse densità di poliuretano e inserti di Cloud Foam e trapuntino in Microflock per offrire pieno comfort e flessibilità dando vita a configurazioni che spaziano dalle più classiche e tradizionali a quelle più contemporanee. Disponibile in due versioni: Dao Soft Base con un basamento rivestito in tessuto o pelle come il rivestimento principale e Dao Soft Light con piedini neri per un uso più funzionale. Una proposta che esprime il proprio animo sartoriale nelle preziose cuciture "a pizzicotto" che definiscono l'estetica del rivestimento in tessuto o in pelle.

A sectional sofa, which allows extreme modularity freedom in a geometric harmony of soft volumes that, in their visual simplicity, immediately invites you to experience calm and relaxation, tuning in to the rhythm of your breathing. Dao Soft, the new furnishing proposal designed by Gordon Guillaumier, features high backrests and seat elements padded with different densities of polyurethane and Cloud Foam inserts with Microflock quilts to offer full comfort and flexibility, allowing configurations going from the most classic and traditional to the most contemporary ones. Available in two versions: Dao Soft Base with base covered in fabric or leather like main cover and Dao Soft Light with black feet for a more functional use. A proposal that expresses its sartorial spirit in the precious sewing "a pizzicotto" that defines the aesthetics with cover in fabric or in leather.



Struttura: legno multistrato imbottito in poliuretano espanso indeformabile e Cloud Foam (tipo 1), rivestito con trapuntino in Microflock (poliestere rigenerato).

Basamento DAO SOFT BASE: multistrato rivestito con fodera fissa nello stesso materiale e colore del rivestimento dell'elemento.

Basamento DAO SOFT LIGHT: con piedino nero.

Rivestimento: sfoderabile in tessuto, fisso in pelle.

Cucitura: pizzicotto.

ACCESSORI:

| tavolini: Struttura in legno per **tavolini "B" per la sola versione Dao Soft Base** utilizzabili all'interno di composizioni di divani in laccato lucido colore Lino, Curry, Corallo, Oliva, Oceano, Salvia, Cipria, Tortora e Nero con base in multistrato rivestito con fodera fissa nello stesso materiale e colore del rivestimento del divano.

Struttura in legno per **tavolini "L"** utilizzabili esclusivamente a lato del divano in laccato lucido colore Lino, Curry, Corallo, Oliva, Oceano, Salvia, Cipria, Tortora e Nero.

Structure: plywood padded with non-deformable polyurethane foam and Cloud Foam (type 1), covered with quilt in Microflock (reconditioned polyester).

Base DAO SOFT BASE: plywood with fix cover in the same material and colour as the element cover.

Base DAO SOFT LIGHT: with black feet.

Cover: removable in fabric, fix in leather.

Sewing: pizzicotto.

ACCESSORIES:

| small tables: Wooden structure **small tables "B" for the Dao Soft Base version** only to be used in the middle of the sofa composition in glossy lacquered colour Lino, Curry, Corallo, Oliva, Oceano, Salvia, Cipria, Tortora and Nero; with base in plywood with fix cover in the same material and colour as the sofa cover.

Wooden structure **small table "L"** to be used at the side of the sofa composition in glossy lacquered colour Lino, Curry, Corallo, Oliva, Oceano, Salvia, Cipria, Tortora and Nero.

DAO SOFT BASE



DAO SOFT BASE

Versione con basamento a terra rivestito con fodera fissa nello stesso materiale e colore del rivestimento.

Version with base on floor with fixed upholstery in the same material and colour of the cover.



TAVOLINO / SMALL TABLE

Tavolino laccato lucido con piedini per uso integrato nel divano o free-standing.

Small table glossy lacquered with feet for integrated use in the sofa or free-standing.



TAVOLINO CON BASE IMBOTTITA / SMALL TABLE WITH PADDED BASE

Tavolino laccato lucido con base imbottita per uso integrato nel divano.

Small table glossy lacquered with padded base for integrated use in the sofa.

DAO SOFT LIGHT



DAO SOFT LIGHT

Versione con piedino.

Version with feet.



TAVOLINO / SMALL TABLE

Tavolino laccato lucido con piedini per uso integrato nel divano o free-standing.

Small table glossy lacquered with feet for integrated use in the sofa or free-standing.



TAVOLINO / SMALL TABLE

Tavolino laccato lucido con piedini per uso integrato nel divano o free-standing.

Small table glossy lacquered with feet for integrated use in the sofa or free-standing.

DAO SOFT BASE SOFA Design Gordon Guillaumier

DAO SOFT BASE / d. 93 cm

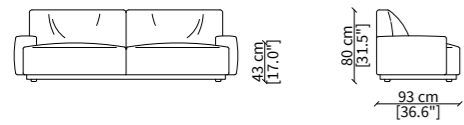

DIVANI / SOFAS

20500 20501

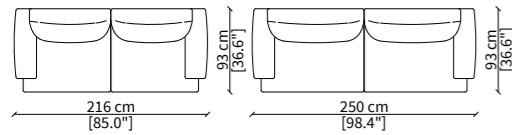

ELEMENTI TERMINALI / TERMINAL ELEMENTS

20503 20504 20505 20506

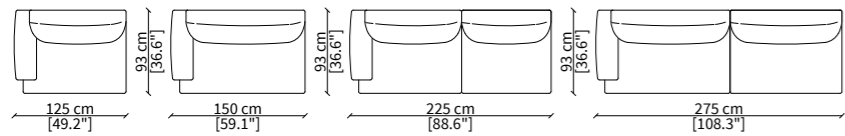

ELEMENTI CENTRALI / CENTRAL ELEMENTS

20507 20508

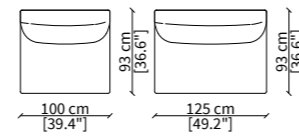

ELEMENTI DORMEUSE / DORMEUSE ELEMENTS

20509 20510

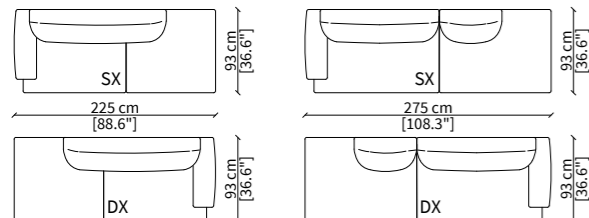

ELEMENTI CENTRALI DORMEUSE / CENTRAL DORMEUSE ELEMENTS

20511

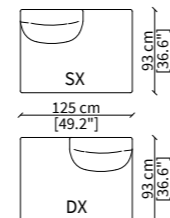

CHAISES LONGUE

20512

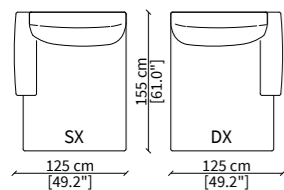

Dimensioni espresse in cm se non diversamente indicato.
L'Azienda si riserva il diritto di apportare modifiche ai modelli senza preavviso.
Tolleranza sulle misure indicate di +/- 2%.

Dimensions in centimeter if not differently indicated.
The Company reserves the right to change the models without any advance notice.
Tolerance on the given sizes +/- 2%.

DAO SOFT BASE SOFA Design Gordon Guillaumier

ELEMENTI DORMEUSE GEOMETRICHE / GEOMETRICAL DORMEUSE ELEMENTS
20513

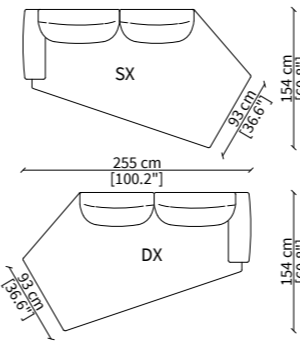

CENTRALI DORMEUSE GEOMETRICHE / CENTRAL DORMEUSE ELEMENTS
20514

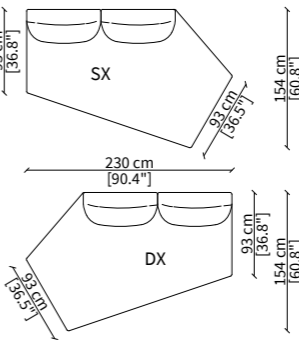

ELEMENTI CENTRALI COMFORT / CENTRAL COMFORT ELEMENTS
20515

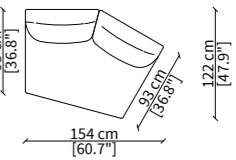

CENTRALE DORMEUSE COMFORT / CENTRAL DORMEUSE COMFORT
20516

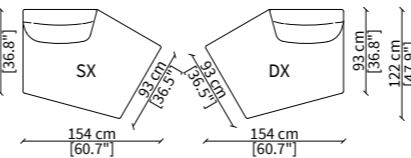

CENTRALE DORMEUSE PENTAGONALE / CENTRAL PENTAGONAL DORMEUSE
20517

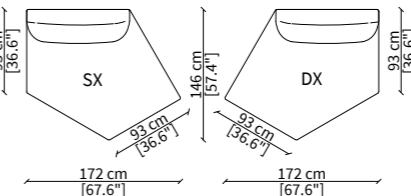

CENTRALE DORMEUSE ESAGONALE / CENTRAL HEXAGONAL DORMEUSE
20518

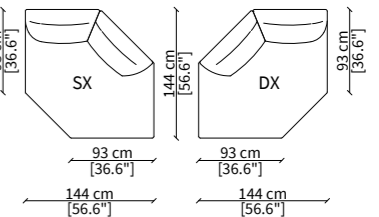

ELEMENTO ANGOLO / CORNER ELEMENT

20519

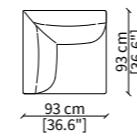

ELEMENTO ANGOLO ESAGONALE / HEXAGONAL CORNER ELEMENT

20520

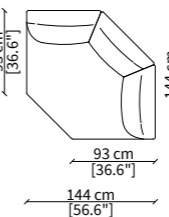

ELEMENTO ANGOLO PENTAGONALE / PENTAGONAL CORNER ELEMENT

20521

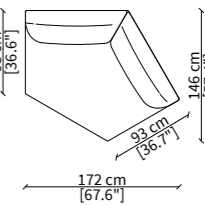

DIVANI ANGOLO / CORNER SOFAS

20522

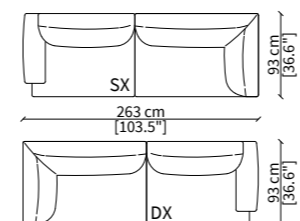

20523

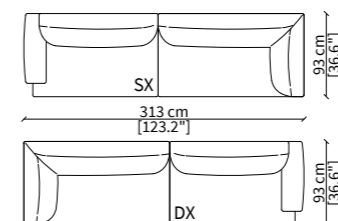

ELEMENTO ANGOLO DORMEUSE / DORMEUSE CORNER ELEMENT

20524

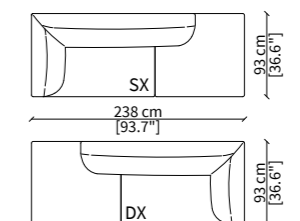

20525

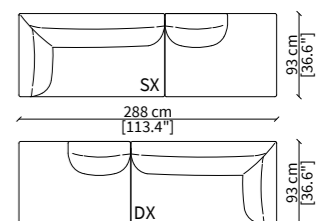

Dimensioni espresse in cm se non diversamente indicato.
L'Azienda si riserva il diritto di apportare modifiche ai modelli senza preavviso.
Tolleranza sulle misure indicate di +/- 2%.

Dimensions in centimeter if not differently indicated.
The Company reserves the right to change the models without any advance notice.
Tolerance on the given sizes +/- 2%.

DAO SOFT BASE SOFA Design Gordon Guillaumier

POUFS

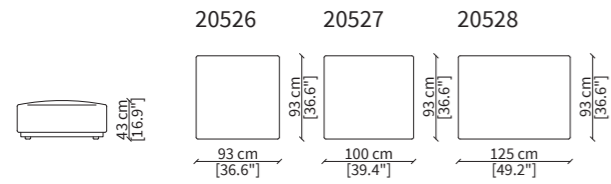

CUSCINI / CUSHIONS

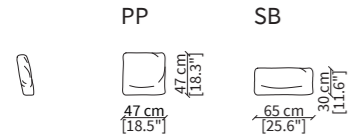

TAVOLINI CENTRALI / CENTRAL TABLES

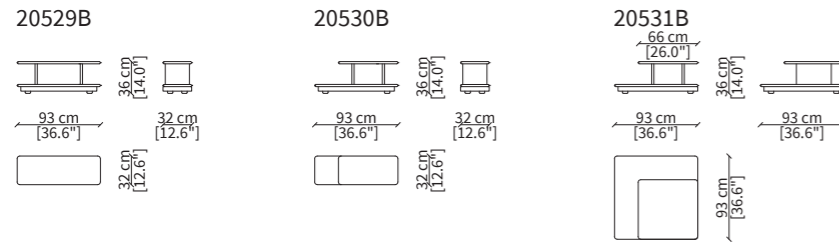

TAVOLINI LATERALI / SIDE TABLES

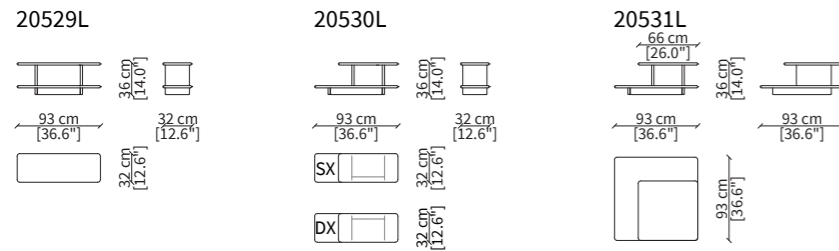

Dimensioni espresse in cm se non diversamente indicato.
L'Azienda si riserva il diritto di apportare modifiche ai modelli senza preavviso.
Tolleranza sulle misure indicate di +/- 2%.

Dimensions in centimeter if not differently indicated.
The Company reserves the right to change the models without any advance notice.
Tolerance on the given sizes +/- 2%.

DAO SOFT BASE SOFA Design Gordon Guillaumier

ESEMPI DI COMPOSIZIONE AD ANGOLO / EXAMPLES OF CORNER COMPOSITIONS

Le composizioni ad angolo possono essere così realizzate:
Corner composition can be built as follows:

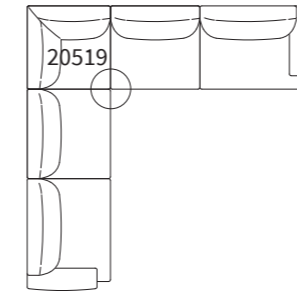

1. utilizzando l'angolo (art. **20519**) per un allineamento preciso delle sedute.

1. by using the corner (art. **20519**) for a perfect alignment of the seats.

ESEMPI DI COMPOSIZIONE AD ANGOLO CON TAVOLINO / EXAMPLES OF CORNER COMPOSITIONS WITH SMALL TABLE

Le composizioni ad angolo possono essere così realizzate:
Corner composition can be built as follows:

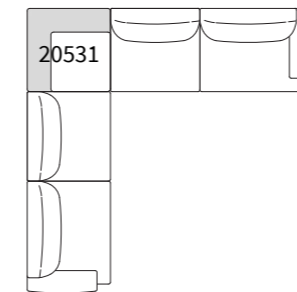

1. utilizzando il tavolino quadrato (art. **20531**), disposto in modo tale da mantenere una continuità di seduta, come angolo.

1. by using the square table (art. **20531**), arranged to maintain continuity of seating, as a corner.

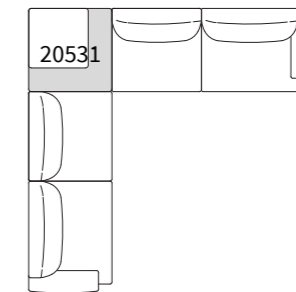

2. utilizzando il tavolino quadrato (art. **20531**), ruotato di 180°, come angolo.

2. by using the square table (art. **20531**), rotated by 180°, as a corner.

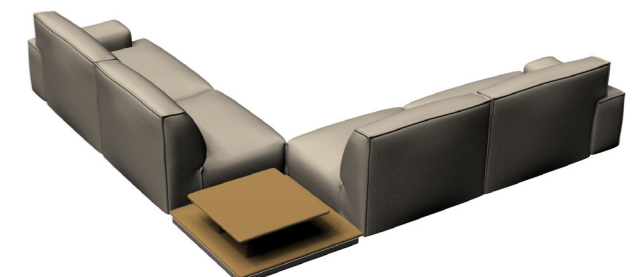
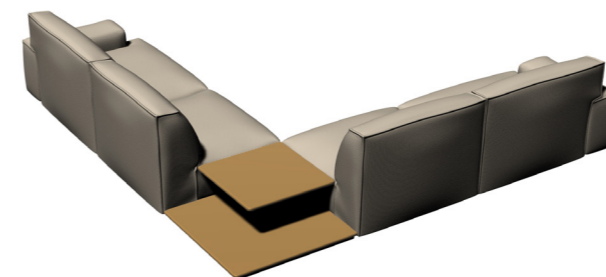

Dimensioni espresse in cm se non diversamente indicato.
L'Azienda si riserva il diritto di apportare modifiche ai modelli senza preavviso.
Tolleranza sulle misure indicate di +/- 2%.

Dimensions in centimeter if not differently indicated.
The Company reserves the right to change the models without any advance notice.
Tolerance on the given sizes +/- 2%.

DAO SOFT BASE SOFA
Design Gordon Guillaumier

COMPOSIZIONE 1 / COMPOSITION 1

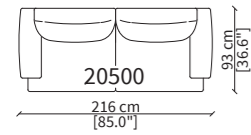

CODICI / CODES: **20500**

COMPOSIZIONE 2 / COMPOSITION 2

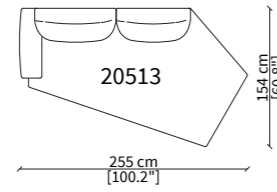

CODICI / CODES: **20513**

COMPOSIZIONE 3 / COMPOSITION 3

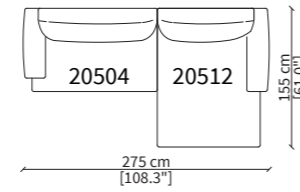

CODICI / CODES: **20504, 20512**

DAO SOFT BASE SOFA
Design Gordon Guillaumier

COMPOSIZIONE 10 / COMPOSITION 10

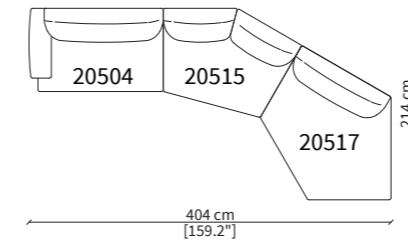

CODICI / CODES: **20504, 20515, 20517**

COMPOSIZIONE 11 / COMPOSITION 11

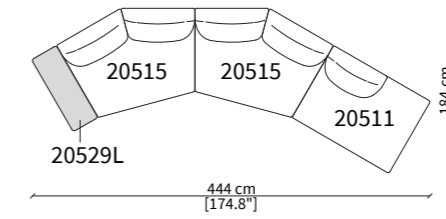

CODICI / CODES: **20529L, 20515 x 2, 20511**

COMPOSIZIONE 12 / COMPOSITION 12

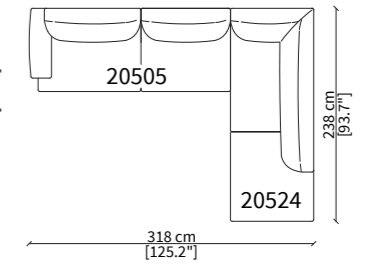

CODICI / CODES: **20505, 20524**

COMPOSIZIONE 4 / COMPOSITION 4

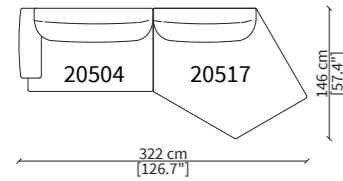

CODICI / CODES: **20504, 20517**

COMPOSIZIONE 5 / COMPOSITION 5

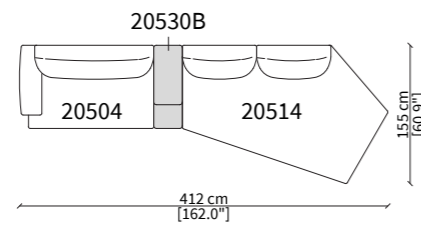

CODICI / CODES: **20504, 20530B, 20514**

COMPOSIZIONE 6 / COMPOSITION 6

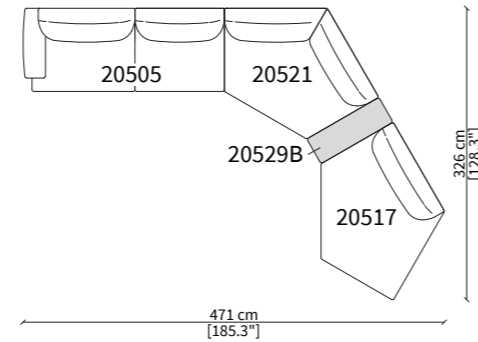

CODICI / CODES: **20505, 20521, 20529B, 20517**

COMPOSIZIONE 7 / COMPOSITION 7

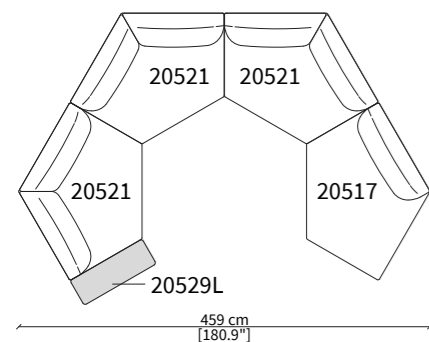

CODICI / CODES: **20529L, 20521 x 3, 20517**

COMPOSIZIONE 8 / COMPOSITION 8

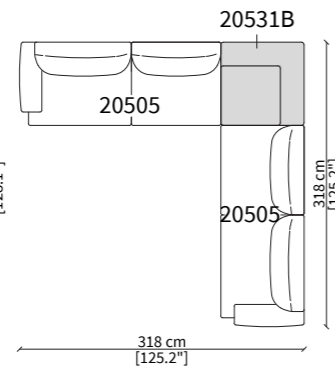

CODICI / CODES: **20505 x 2, 20531B**

COMPOSIZIONE 9 / COMPOSITION 9

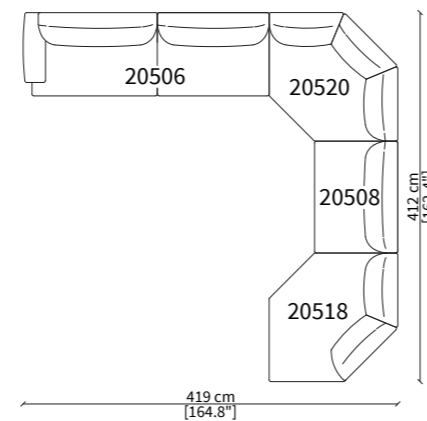

CODICI / CODES: **20506, 20520, 20508, 20518**

Dimensioni espresse in cm se non diversamente indicato.
L'Azienda si riserva il diritto di apportare modifiche ai modelli senza preavviso.
Tolleranza sulle misure indicate di +/- 2%.

Dimensions in centimeter if not differently indicated.
The Company reserves the right to change the models without any advance notice.
Tolerance on the given sizes +/- 2%.

Dimensioni espresse in cm se non diversamente indicato.
L'Azienda si riserva il diritto di apportare modifiche ai modelli senza preavviso.
Tolleranza sulle misure indicate di +/- 2%.

Dimensions in centimeter if not differently indicated.
The Company reserves the right to change the models without any advance notice.
Tolerance on the given sizes +/- 2%.

DAO SOFT LIGHT SOFA Design Gordon Guillaumier

DAO SOFT LIGHT / d. 93 cm

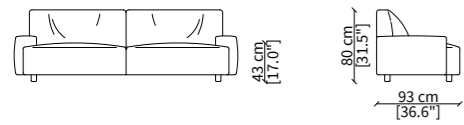

DIVANI / SOFAS

22400 22401

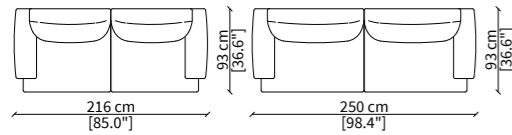

ELEMENTI TERMINALI / TERMINAL ELEMENTS

22402 22403 22404 22405

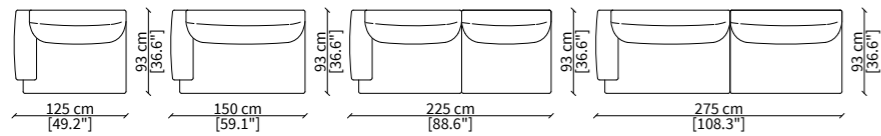

ELEMENTI CENTRALI / CENTRAL ELEMENTS

22406 22407

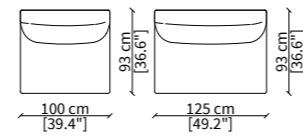

ELEMENTI DORMEUSE / DORMEUSE ELEMENTS

22408 22409

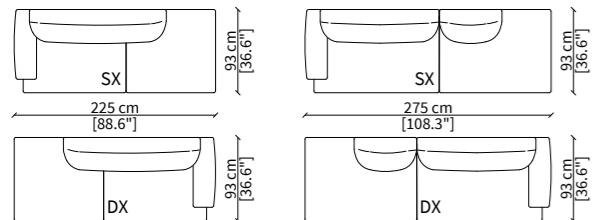

ELEMENTI CENTRALI DORMEUSE / CENTRAL DORMEUSE ELEMENTS

22410

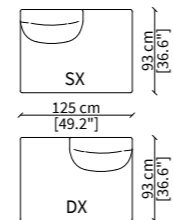

CHAISES LONGUE

22411

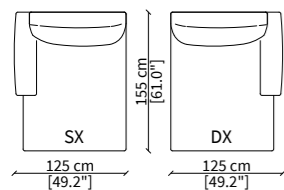

Dimensioni espresse in cm se non diversamente indicato.
L'Azienda si riserva il diritto di apportare modifiche ai modelli senza preavviso.
Tolleranza sulle misure indicate di +/- 2%.

Dimensions in centimeter if not differently indicated.
The Company reserves the right to change the models without any advance notice.
Tolerance on the given sizes +/- 2%.

DAO SOFT LIGHT SOFA Design Gordon Guillaumier

ELEMENTI DORMEUSE GEOMETRICHE / GEOMETRICAL DORMEUSE ELEMENTS 22412

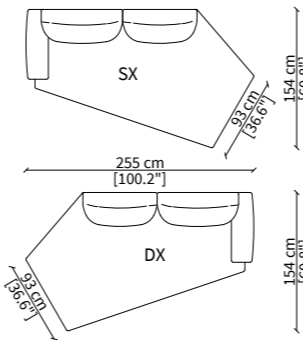

CENTRALI DORMEUSE GEOMETRICHE / CENTRAL DORMEUSE ELEMENTS 22413

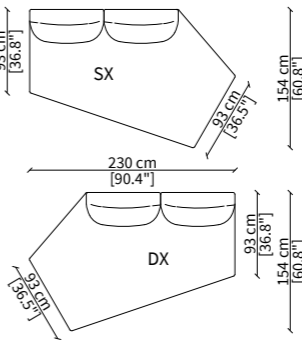

ELEMENTI CENTRALI COMFORT / CENTRAL COMFORT ELEMENTS 22414

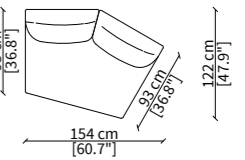

CENTRALE DORMEUSE COMFORT / CENTRAL DORMEUSE COMFORT 22415

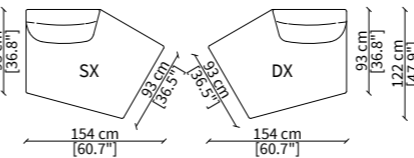

CENTRALE DORMEUSE PENTAGONALE / CENTRAL PENTAGONAL DORMEUSE 22416

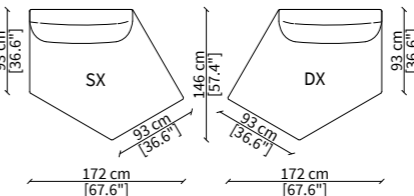

CENTRALE DORMEUSE ESAGONALE / CENTRAL HEXAGONAL DORMEUSE 22417

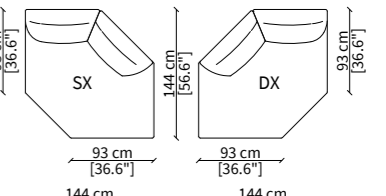

ELEMENTO ANGOLO / CORNER ELEMENT

22418

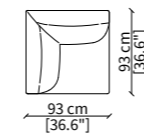

ELEMENTO ANGOLO ESAGONALE / HEXAGONAL CORNER ELEMENT 22419

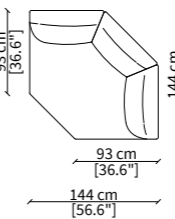

ELEMENTO ANGOLO PENTAGONALE / PENTAGONAL CORNER ELEMENT 22420

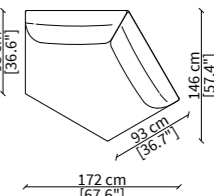

DIVANI ANGOLO / CORNER SOFAS

22421

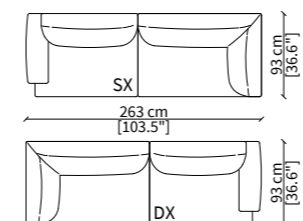

22422

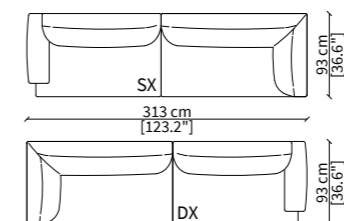

ELEMENTO ANGOLO DORMEUSE / DORMEUSE CORNER ELEMENT

22423

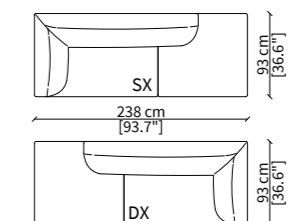

22424

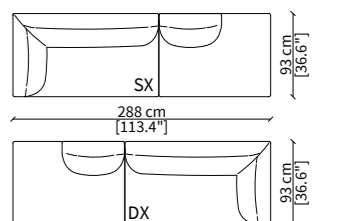

Dimensioni espresse in cm se non diversamente indicato.
L'Azienda si riserva il diritto di apportare modifiche ai modelli senza preavviso.
Tolleranza sulle misure indicate di +/- 2%.

Dimensions in centimeter if not differently indicated.
The Company reserves the right to change the models without any advance notice.
Tolerance on the given sizes +/- 2%.

DAO SOFT LIGHT SOFA Design Gordon Guillaumier

POUFS

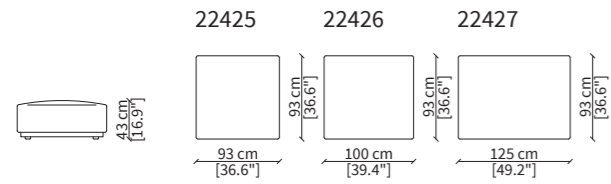

CUSCINI / CUSHIONS



TAVOLINI / SMALL TABLES

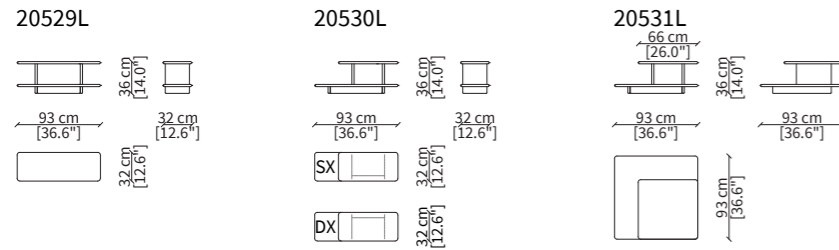

Dimensioni espresse in cm se non diversamente indicato.
L'Azienda si riserva il diritto di apportare modifiche ai modelli senza preavviso.
Tolleranza sulle misure indicate di +/- 2%.

Dimensions in centimeter if not differently indicated.
The Company reserves the right to change the models without any advance notice.
Tolerance on the given sizes +/- 2%.

DAO SOFT LIGHT SOFA Design Gordon Guillaumier

ESEMPI DI COMPOSIZIONE AD ANGOLO / EXAMPLES OF CORNER COMPOSITIONS

Le composizioni ad angolo possono essere così realizzate:
Corner composition can be built as follows:

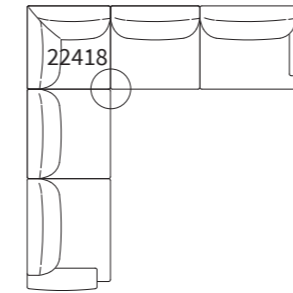

1. utilizzando l'angolo (art. **22418**) per un allineamento preciso delle sedute.

1. by using the corner (art. **22418**) for a perfect alignment of the seats.

ESEMPI DI COMPOSIZIONE AD ANGOLO CON TAVOLINO / EXAMPLES OF CORNER COMPOSITIONS WITH SMALL TABLE

Le composizioni ad angolo possono essere così realizzate:
Corner composition can be built as follows:

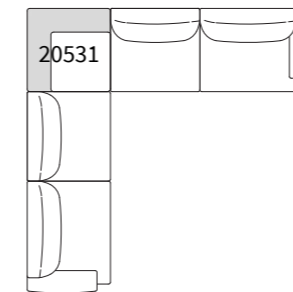

1. utilizzando il tavolino quadrato (art. **20531**), disposto in modo tale da mantenere una continuità di seduta, come angolo.

1. by using the square table (art. **20531**), arranged to maintain continuity of seating, as a corner.

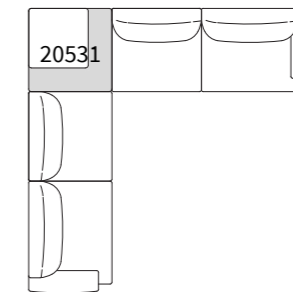

2. utilizzando il tavolino quadrato (art. **20531**), ruotato di 180°, come angolo.

2. by using the square table (art. **20531**), rotated by 180°, as a corner.

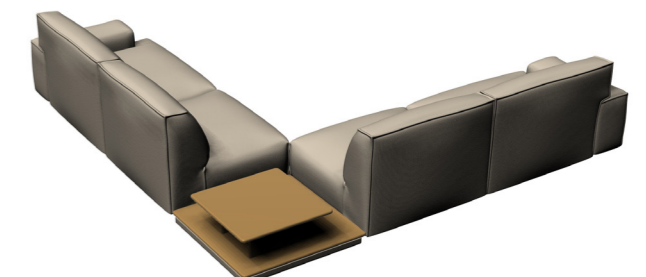
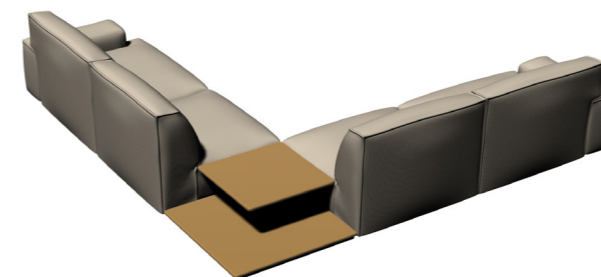

Dimensioni espresse in cm se non diversamente indicato.
L'Azienda si riserva il diritto di apportare modifiche ai modelli senza preavviso.
Tolleranza sulle misure indicate di +/- 2%.

Dimensions in centimeter if not differently indicated.
The Company reserves the right to change the models without any advance notice.
Tolerance on the given sizes +/- 2%.

DAO SOFT LIGHT SOFA Design Gordon Guillaumier

COMPOSIZIONE 1 / COMPOSITION 1

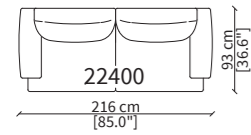

CODICI / CODES: **22400**

COMPOSIZIONE 2 / COMPOSITION 2

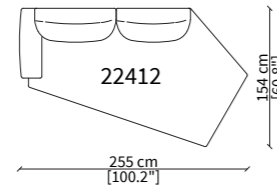

CODICI / CODES: **22412**

COMPOSIZIONE 3 / COMPOSITION 3

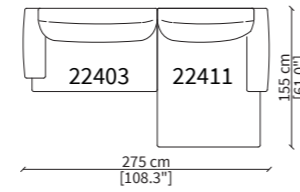

CODICI / CODES: **22403, 22411**

DAO SOFT LIGHT SOFA Design Gordon Guillaumier

COMPOSIZIONE 10 / COMPOSITION 10

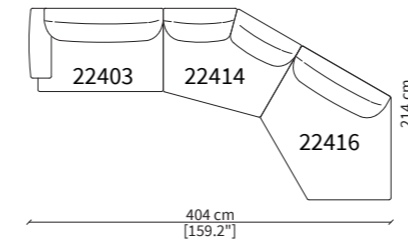

CODICI / CODES: **22403, 22414, 22416**

COMPOSIZIONE 11 / COMPOSITION 11

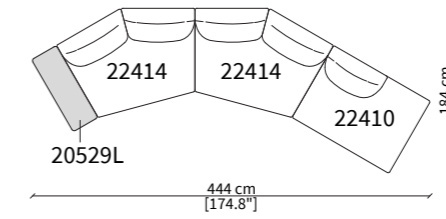

CODICI / CODES: **20529L, 22414 x 2, 22410**

COMPOSIZIONE 12 / COMPOSITION 12

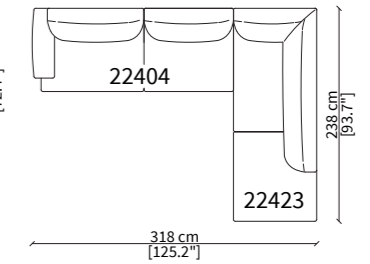

CODICI / CODES: **22404, 22423**

COMPOSIZIONE 4 / COMPOSITION 4

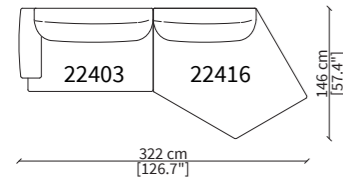

CODICI / CODES: **22403, 22416**

COMPOSIZIONE 5 / COMPOSITION 5

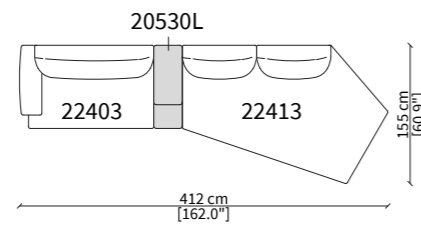

CODICI / CODES: **22403, 20530L, 22413**

COMPOSIZIONE 6 / COMPOSITION 6

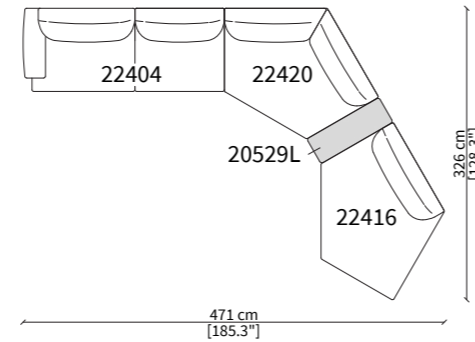

CODICI / CODES: **22404, 22420 20529L, 22416**

COMPOSIZIONE 7 / COMPOSITION 7

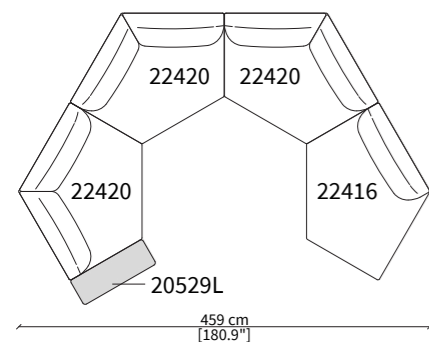

CODICI / CODES: **20529L, 22420 x 3, 22416**

COMPOSIZIONE 8 / COMPOSITION 8

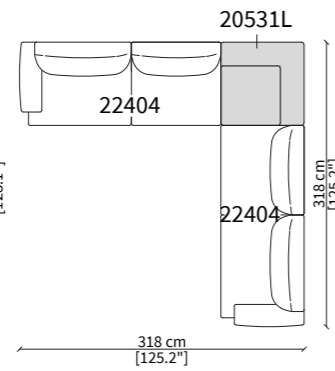

CODICI / CODES: **22404 x 2, 20531L**

COMPOSIZIONE 9 / COMPOSITION 9

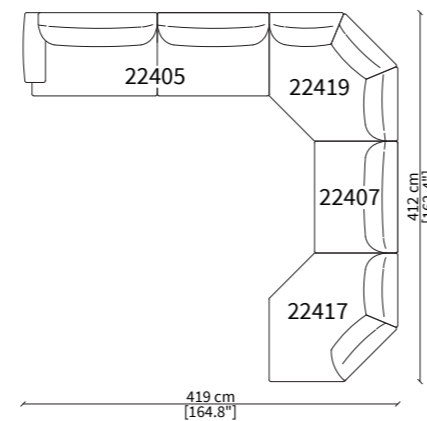

CODICI / CODES: **22405, 22419, 22407, 22417**

Dimensioni espresse in cm se non diversamente indicato.
L'Azienda si riserva il diritto di apportare modifiche ai modelli senza preavviso.
Tolleranza sulle misure indicate di +/- 2%.

Dimensions in centimeter if not differently indicated.
The Company reserves the right to change the models without any advance notice.
Tolerance on the given sizes +/- 2%.

Dimensioni espresse in cm se non diversamente indicato.
L'Azienda si riserva il diritto di apportare modifiche ai modelli senza preavviso.
Tolleranza sulle misure indicate di +/- 2%.

Dimensions in centimeter if not differently indicated.
The Company reserves the right to change the models without any advance notice.
Tolerance on the given sizes +/- 2%.

Per la gamma completa di materiali è possibile consultare il nostro sito web www.frigerio.com
The full range of materials can be found on our website at www.frigerio.com.

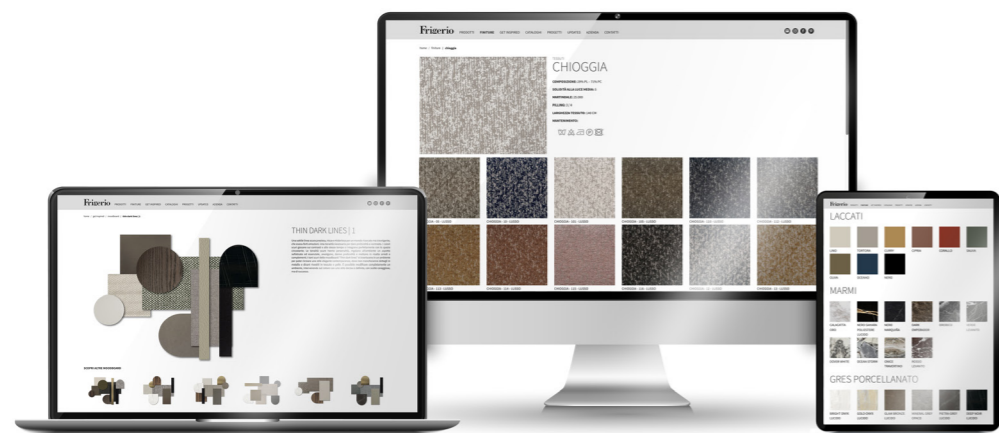

WWW.FRIGERIO.COM

Frigerio

Via Sant'Agata 63
22066 Mariano Comense (CO) - Italy
Tel. +39 031 5481225
info@frigerio.com
www.frigerio.com